

UDC 624.014

## EXPERIMENTAL RESEARCHES OF THE CURRENT BURDENING COURSE PLATES ACHIEVEMENTS

Storozhenko Leonid<sup>1</sup>, Yermolenko Dmytro<sup>2\*</sup>, Tegza Ivan<sup>3</sup>

<sup>1</sup> Poltava National Technical Yuri Kondratyuk University <https://orcid.org/0000-0002-3764-5641>

<sup>2</sup> Poltava National Technical Yuri Kondratyuk University <https://orcid.org/0000-0001-6690-238X>

<sup>3</sup> Poltava National Technical Yuri Kondratyuk University <https://orcid.org/0000-0001-7729-4615>

\*Corresponding author E-mail: yermolenko-da@ukr.net

The article presents the experimental study results of flat intercolumn plates loading work peculiarities of the beamless overlapping developed system. The attention is paid to the design of the experimental designs of the bearing structure with the bevelled platforms of suspension on the outer perimeter of the span plates. The technique of performing experimental studies is presented. The conducted researches enabled to establish the nature of deformation and destruction of intercolumn plates as a separate element in the developed system of beamless overlapping. In this case, the magnitude of the compression deformations decreases to the point where the test specimens rest on the supporting blocks. It confirms the assumption of the transfer of load from the spacers to the intercolumnar on the principle of "linear hinge". Attention is paid to the fact that the achievement of the bearing capacity is not accompanied by the process of destruction, but is characterized by significant movements of the flying part of the plate in the vertical plane.

**Keywords:** displacement, bearing capacity, deformed state, experimental research, unbounded overlap

## ЕКСПЕРИМЕНТАЛЬНІ ДОСЛІДЖЕННЯ МІЖКОЛОННОЇ ПЛИТИ ЗБІРНОГО БЕЗБАЛКОВОГО ПЕРЕКРИТТЯ

Стороженко Л.І.<sup>1</sup>, Єрмоленко Д.А.<sup>2\*</sup>, Тегза І.І.<sup>3</sup>

<sup>1, 2, 3</sup> Полтавський національний технічний університет імені Юрія Кондратюка

\*Адреса для листування E-mail: yermolenko-da@ukr.net

У статті наведено результати експериментального дослідження особливостей роботи під розрахунковим навантаженням плоских міжколонних плит розробленої системи безбалкового перекриття. Приділено велику увагу конструюванню дослідних зразків несучої конструкції. Особливістю плити, що досліджується є скошені майданчики спирання по зовнішньому периметру пролітних плит та скошені опорні ділянки. Описано конструкцію та технологію виготовлення додаткового устаткування, що імітає спирання міжколонної плити вищого рівня у вигляді залізобетонних опорних масивних блоків. Для неможливлення зміщення блоки об'єднано сталевими прутами. Дослідні конструкції плити і допоміжного устаткування виготовлено на обладнанні та в умовах діючого заводу залізобетонних виробів. Наведено методику виконання експериментальних досліджень із вказуванням методів і засобів вимірювання геометричних та фізичних параметрів, що характеризують напружено-деформований стан та несучу здатність дослідної плити. Проведені дослідження дали змогу встановити характер деформування і руйнування міжколонних плит як окремого елемента у розробленій системі безбалкового перекриття. Аналіз характеру деформування свідчить, що деформації розтягу на нижньої грані дослідної плити наростають швидше ніж деформації стиснення (верхньої грані). При цьому відбувається зменшення величини стискаючих деформацій до місця спирання дослідних зразків на опорні блоки. Це підтверджує припущення про передачу навантаження від пролітних плит на міжколонну за принципом «лінійного шарніру». Звернута увага на те, що досягнення несучої здатності не супроводжується процесом руйнування, а характеризується суттєвими переміщеннями пролітної частини плити у вертикальній площині.

**Ключові слова:** переміщення, несуча здатність, деформований стан, експериментальні дослідження, безбалкове перекриття



## Introduction

Modern tasks of construction development are becoming new requirements for the production of building structures and their modernization on the basis of scientific and technological progress. A significant effect in the implementation of new modernized structural solutions can be achieved due to the optimal combination of physical and technical parameters of elements in the scheme "design material technology". Under this scheme, the bulk of the savings are formed, firstly, at the expense of the widest use of existing potential of precast concrete structures, in particular the use of circular hollow slabs, and secondly, the use of progressive reinforced concrete cones - structures that combine the advantages of steel and concrete and allow to reduce the structural height of the frame elements.

Nowadays, joists are used in the construction of joistless, ungrounded, and non-rigid overlapping structures. Such design systems allow the construction of arbitrary configuration buildings in the plan with different planning and planning solutions. A further step in the modification of prefabricated and prefabricated monolithic frames of buildings and structures is the combination of prefabricated circular hollow slabs, their modifications and steel-lizoboton beamless frame. Tasks aimed at finding rational parameters of such structures, investigating their strength and deformation properties and implementing the results in construction are appropriate and relevant.

## Review of research sources and publications

Along with the existing types, new progressive structures of reinforced concrete have been developed to reduce the cost of installing console construction, to refrain from the formwork and additional racks and to increase the speed of installation. Various systems of non-beam overlaps have been widely considered [1]. They all have advantages, but not without disadvantages. Material and labour costs for their installation are significant.

The system of beamless overlapping with modified multi-hollow plates [2, 3], designed by the authors, is able to provide optimum due to the plates layout joints total length and strength and does not require large material and labour costs for the installation and replacement of joints between individual plates. This is achieved by the fact that precast, intercolumnar and span slabs are used in precast concrete precast slabs, with slabs along the perimeter having sloping lateral faces forming a platform for supporting adjacent slabs [4]. The overall stiffness of the flooring is achieved by welding together the mortgages that are pre-seen on all slabs. To put into practice the construction of such overlapping systems, the necessary proposals for their design and, in particular, the calculation of the strength of the individual elements and the whole system as a whole are necessary.

## Definition of unsolved aspects of the problem

At present, there is virtually no data on the robot of individual plates in the composition of beamless overdigging. As a prototype, an over-sized slabless slab of

slabless overlap was selected, which enabled obtaining the most complete information on the object of study.

## Problem statement

The purpose of the experimental researches is to establish a true stress-strain state and to determine the load-bearing capacity of the inter-column slabs of the flat beamless overlap.

## Basic material and results

A program of their experimental studies was developed to identify the peculiarities of interconnector plates work under the influence of external loading (Fig. 1). According to the adopted program of experimental studies, a series of prototypes were made. Concrete formulations and reinforcing bars, which were available at the Svetlovodsk Plant of Reinforced Concrete Products, were used for the samples. The thickness of the test plates was taken 220 mm. Special markings were made on the surface of the specimens to accurately fit the design position. The experimental specimens were filled with C25/30 concrete in strength.

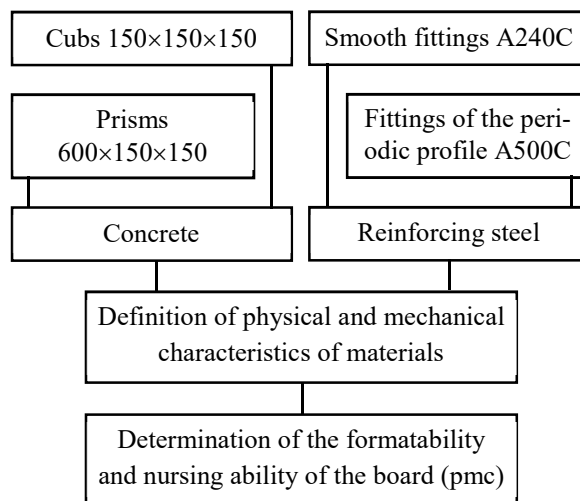

**Figure 1 – Program of experimental research of inter-column slabs of the basal overlapping system.**

*Designs of samples and technology of their manufacture.* Inter-column plates were made and tested at the factory of reinforced concrete products in Svetlovodsk. Fig. 2 shows the test plates on which the measuring marks are glued using the BF-2 adhesive. Marks were used to improve the accuracy of the positioning of control points and characteristic points in photographs. The photographic method is interesting and promising in the first place because it is a non-contact method of determining the deformation of bodies. The essence of the method lies in the measurement of the prototype before and after deformation between point marks, which in our case were marking marks. In this method, photographing of marks was carried out at a distance, so there is no need for direct contact of the devices with the body, as well as the essential positive method is to measure the deformations of distant or complex body shapes.

Figure 3 shows a diagram of the location of the measuring devices on the surface of the test specimens of the intercolumn and flight plates of the series, respectively PMC and software.

In order to be able to mount in the working position of the test specimens of inter-column (PMK) and fly-in

(SO) slabs, two concrete blocks with a cut one upper edge were made. To prevent movement during loading, these support blocks were joined by two steel rods. The latter were omitted in the pre-formed holes (Fig. 4).



Figure 2 – Experimental design of the intercolumn plate on the test bench.

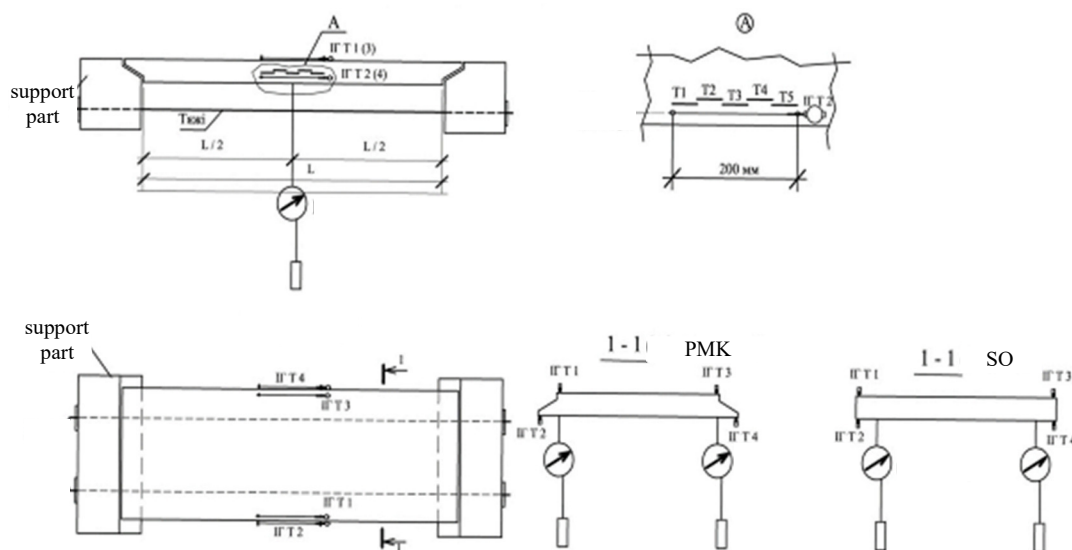

Figure 3 – Arrangement of measuring devices on the intercolumn plate



Figure 4 – Supporting blocks for testing of PMC series plates

Inventory cargo blocks with a calibrated weight of 1.96 tons were used as a useful load for the PMK test plates. The overall dimensions of such blocks were 600×600×2200 mm.

The results of the experimental pre-investigations of the developed PMC intercolumn plates, indicated a number of disadvantages of ordinary working rein-

forcement. This plate design had sufficient bearing capacity, but displacement and fracture toughness were not sufficiently secured, as evidenced by the magnitudes of the parameters that characterize them. In the practice of designing reinforced concrete structures, the practice of replacing conventional strength reinforcement with high strength is widely used, such replacement allows the use of pre-stressed working reinforcement.

To evaluate the efficiency of the use of pre-stress in the intercolumn slabs, prototypes of such slabs were made (Fig. 5). The following used: concrete of class C16/20; armature valve  $\varnothing 14$  A800, mounting –  $\varnothing 6$  A11.

The laboratory tests of reference specimens of cubes and prisms obtained mechanical properties of concrete. The cubic strength of the control samples was  $f_{ck,cube} = 26,4$  MPa, prism –  $f_{ck,prism} = 15,0$  MPa, the initial modulus of concrete  $E_{ck} = 23,0$  GPa, the coefficient of transverse deformation –  $\nu = 0.19$ . The characteristics obtained correspond to the design class of C16/20 concrete.

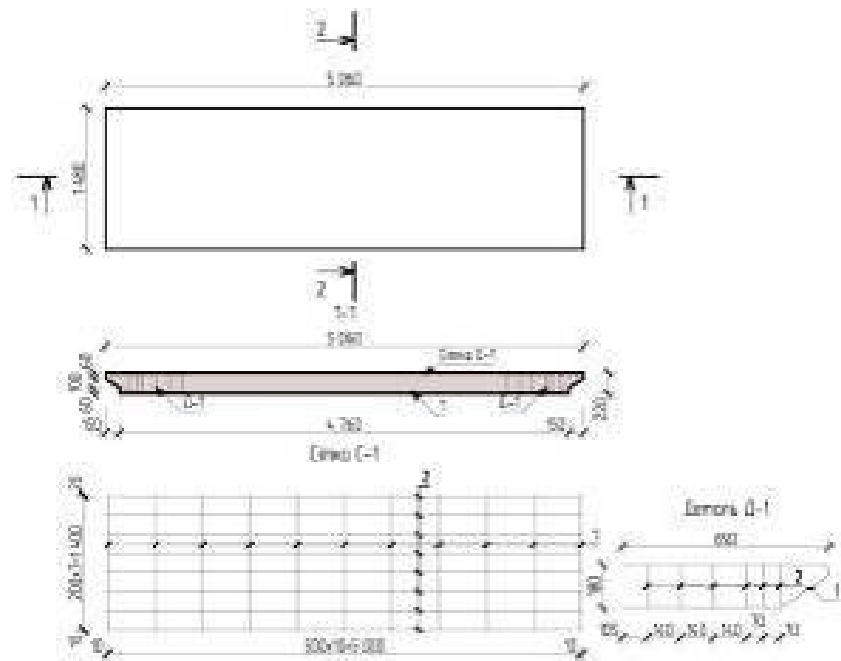

Figure 5 – Reinforcing frame and PMC parts

The steel physical and mechanical properties determination was carried out by testing 3 standard samples in the form of rods.

On the sections of the armature were placed electro-strain gauges on two opposite sides. Adjusted cores were tested on a universal tensile test machine.

The stresses, which corresponded to the yield strength and the temporary resistance of the material, were determined according to the diagram  $\sigma - \varepsilon$ . The resistance of steel  $f_y$  and  $f_u$  was assumed to be the average of the minimum of the test specimens. The modulus of elasticity of the steel was determined by the diagram,  $E_s = 2,1 \times 10^5$  MPa.

Figure 6 shows a graph of the deflection distribution on the concrete surface at the level of the upper compressed fibre and at the axis level of the lower working armature. Initially, up to  $0,4 F_{max}$  the increment of deformations occurs in proportion to the increment of the load. It should be noted that the graphs have several points at which the deformation increment changes depending on the load value. This can be explained by the specific procedure of loading the test plate with the help of inventory loads. The weight of each such cargo amounted to 16,3 kN (Fig. 7).

The graphs can highlight the moment when a substantial increase in strain in the stretched zone is doubled by the same increase in deformation of the compressed zone. At this point, the sum of the total extracurricular effort amounted to 163 kH.

During unloading, the test plate was deformed in the opposite direction. It led to the closure of the cracks in the stretched area, but some residual deformation was preserved. So in the cramped zone they reached the magnitude of  $47 \times 10^{-5}$ , and in the stretched –  $30 \times 10^{-5}$ .

It should be noted that this character of the development of longitudinal deformations is confirmed by the graph of the change in the magnitude of the vertical displacements of the middle cross-section (Fig. 8) of the

intercolumn plate with the prestressing of the lower working armature.

Increasing the total load to 163 kN led to the appearance of "hair" cracks (Fig. 9). Crack propagation reaches 40% of the height of the cross section from the bottom face.

As the load increased, the cracks length increased and the compressed zone decreased by 5–7%. Cracks were also manifested on the lower face of the slab. From Figure 9 it can be seen that the cracks are evenly revealed along the entire cross-section.

The variation of the size of the compressed zone of the middle cross-section is shown in Fig. 10. According to these graphs, it can be seen that from the beginning of loading to loading of  $0,4 F_{max} = 97,8$  kN the height of the compressed zone was 68% of the height of the section of the plate. With the load increasing to 163,0 kN, the height of the compressed zone was 59%. Then it decreased to almost 50%.

The average value of the maximum load according to the test results for the interconnector plates was  $F = 267,3$  kN (bending moment in the average cross section  $M = 151,8$  kN·m).

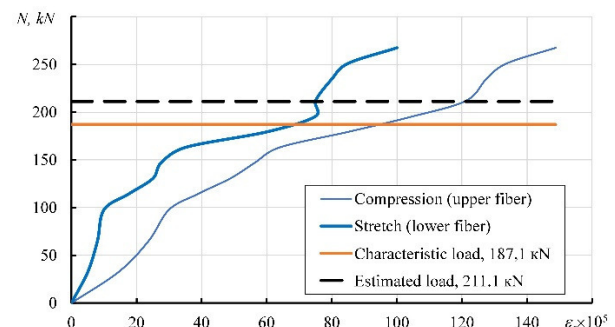
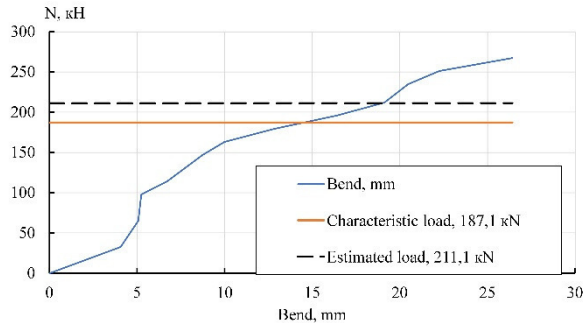

Figure 6 – Development of relative deformations of the upper fiber and at the level of the lower working reinforcement





**Figure 7 – Experimental sample of inter-column slab with pre-stressed working fittings during in-test**



**Figure 8 – Mean section deflections depending on the magnitude of the total load, such as pre-stressed PNC**



**Figure 9 – Occurrence of the first cracks near the average cross section at a total load of 163 kN, such as pre-stressed PNC**

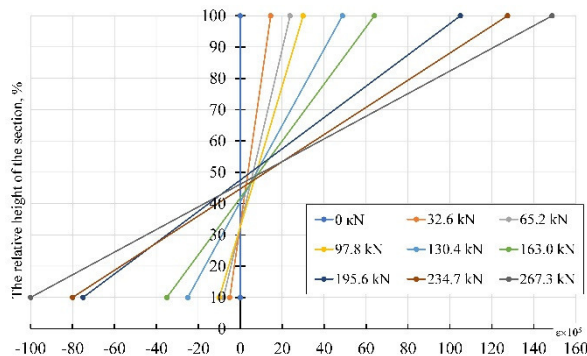
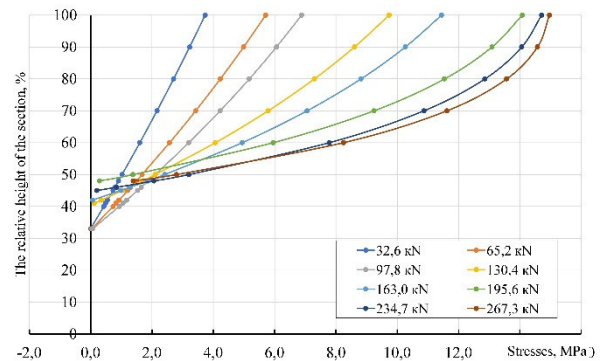

**Figure 10 – Changing the height of the compressed zone depending on the magnitude of the total load, such as pre-stressed PNC**

The results in Table 1 refer to the average cross-section with respect to the plate span. The forces  $N$  (kN), relative deformation  $\varepsilon_{cm} \times 10^{-5}$  and  $\varepsilon_{sm} \times 10^{-5}$  and deflections  $f$  (mm) were measured during the experimental studies. The magnitudes of the outer bending moment  $M$  (кН·м) are calculated in accordance with the actual loading of inventory loads, taking into account their location and the corresponding quantity. The curvature was determined for the corresponding average cross-section depending on the deformation of the plate materials.

Dependences of changes in stresses in concrete of compressed and stretched zones at different loading stages were constructed according to the deformations measured during the test and according to the concrete diagram. The graphs are presented in Fig. 11.

Thus, the load-bearing capacity of the inter-column pre-stressed plate was 258.6 kN. The design of the plate during the experiments did not suffer destruction, but the value of the relative deflection exceeded the limit value in 1/200. Therefore, as a bearing capacity, an effort is taken that corresponds to the magnitude of the regulatory deflection. In this case, the theoretical bearing capacity of the inter-column plate with pre-tension was 211.1 kN. The difference was 21.3%. It can be stated that the theoretical non-shear capacity, which is calculated by the standard methodology, enables to establish with sufficient accuracy the load-bearing capacity of such plates.



**Figure 11 – The change in the stress state of the concrete in the average cross-section depending on the value  $F$  of the sample of PNA with prestress.**

**Table 1 – Results of experimental studies of the interplanar PMK plate**

№	N, kN	M, kN·m	$\varepsilon_{cm} \times 10^{-5}$	$\varepsilon_{sm} \times 10^{-5}$	f, mm
0	0,0	0,00	0,0	0,0	0,00
1	32,6	32,09	14,5	5,0	4,07
2	65,2	52,14	23,8	8,0	5,07
3	97,8	60,71	30,0	10,0	5,24
4	114,1	77,36	38,8	17,5	6,71
5	130,4	86,78	48,8	25,0	7,72
6	146,7	91,14	56,3	27,5	8,73
7	163,0	101,09	64,0	35,0	9,99
8	179,3	117,13	85,0	60,0	12,81
9	195,6	130,12	105,0	75,0	16,38
10	211,9	137,07	121,3	75,0	19,12
11	234,7	137,84	127,5	80,0	20,47
12	251,0	138,82	133,8	85,0	22,25
$F_{max}$	267,3	151,80	148,8	100,0	26,42

Table 2 compares the bearing capacity, the boundary deformations of the extreme fibers of the median section and the deflection of the experimental design of the intercolumn plate with the pre-stressed working reinforcement with theoretical values.

The longitudinal deformation of the compression of the upper compressed fibre in the limit state is understressed by 8%, and the deformation of the lower tensile fibre exceeds the ultimate deformation of the concrete by 35%. The experimental pro-gins almost coincided with their theoretical values.

**Table 2 – Comparison of experimental results and theo-theoretical data**

	Carrying capacity, kN	Deformation, $\varepsilon \times 10^5$		Bend, mm
		compression	stretching	
Experimental	267,3	149	100	26,4
Theoretical	211,1	162	65	26,0
Difference, %	+ 21,3	- 8,7	+ 35	+ 1,5

### Conclusions

The experimental research program was designed to consider the possibility of building structures existing production material base using. It enables to design and manufacture life-size prototypes of real load-bearing structures of a flat, girderless floor. Materials of structures (steel and concrete are used in real load-bearing structures. The test rig is certified.

### References

1. Нижник, О.В. (2012). *Безбалкові та часторебристі сталезалізобетонні перекриття*. – Полтава: Шевченко Р.
2. Стороженко, Л.І., Ермоленко, Д.А., Нижник, О.В., Богоста, В.І., Тегза, І.І. (2014). Нові ефективні рішення безбалкових збірних перекриттів багатопверхових будівель. Збірник наукових праць. Серія: Галузеве машинобудування, будівництво, 3(42), Т.1, 183-187.
3. Стороженко, Л.І., Ермоленко, Д.А., Нижник, О.В., Богоста, В.І., Тегза, І.І. (2018). *Вузол з'єднання плит у збірному безбалковому перекритті*. Патент України № 128581. Київ, Укрпатент
4. Storozhenko, L.I., Nizhnik, O.V., Yermolenko D.A. & Tegza, I.I. (2017). *New design decisions of prefabricated girderless floors of multi-storeyed buildings*. MATEC Web of Conferences 116, 02032 <https://doi.org/10.1051/mateconf/201711602032>
5. Narayanan, R. (1988). *Steel-concrete composite structures: Stability strength*. London-New York: Spon Press.
6. Frangopol, D. & Soliman, M. (2016). Life-cycle of structural systems: Recent achievements and future directions. *Structure and Infrastructure Engineering*, 12(1), 1-20. <https://doi.org/10.1080/15732479.2014.999794>
7. Mullett, D.L. (1998). *Composite floor system*. Wiley-Blackwell.
8. Costa-Neves, L.F., Silva, J.G.S., Lima, L.R.O. & Jordao, S. (2014). Multi-storey, multi-bay building with composite steel-desk floors under human-induced loads. *Computers and Structures*, 136, 34-46. <https://doi.org/10.1016/j.compstruc.2014.01.027>
9. Wright, H.D., Evans, H.R. & Harding, P.W. (1987). The use of profiles steel sheeting in floor construction. *Journal of Constructional Steel Research*, 7(4), 279-295. [https://doi.org/10.1016/0143-974X\(87\)90003-4](https://doi.org/10.1016/0143-974X(87)90003-4)
10. Broms, C.E. (2006). *Concrete Flat Slabs and Footings: Design Method for Punching and Detailing for Ductility*. Royal Institute of Technology. Stockholm, Sweden.
1. Nyzhnyk, A.V. (2012). *Beamless and often ribbed steel-concrete floors*. – Poltava: Shevchenko R.V.
2. Storozhenko, L.I., Yermolenko D.A., Nizhnik, O.V., Bogosta, V.I. & Tegza, I.I. (2014). New effective solutions of beam-free prefabricated overlappings of multi-storey buildings. *Academic journal. Series: Industrial Machine Building, Civil Engineering*, 3(42), v.1., 183-187.
3. Storozhenko, L.I., Yermolenko D.A., Nizhnik, O.V., Bogosta, V.I. & Tegza, I.I. (2018). *Plate connection node in precast beamless overlay*. Patent of Ukraine № 128581. Kyiv, Ukrpatent.
4. Storozhenko, L.I., Nizhnik, O.V., Yermolenko D.A. & Tegza, I.I. (2017). *New design decisions of prefabricated girderless floors of multi-storeyed buildings*. MATEC Web of Conferences 116, 02032 <https://doi.org/10.1051/mateconf/201711602032>
5. Narayanan, R. (1988). *Steel-concrete composite structures: Stability strength*. London-New York: Spon Press.
6. Frangopol, D. & Soliman, M. (2016). Life-cycle of structural systems: Recent achievements and future directions. *Structure and Infrastructure Engineering*, 12(1), 1-20. <https://doi.org/10.1080/15732479.2014.999794>
7. Mullett, D.L. (1998). *Composite floor system*. Wiley-Blackwell.
8. Costa-Neves, L.F., Silva, J.G.S., Lima, L.R.O. & Jordao, S. (2014). Multi-storey, multi-bay building with composite steel-desk floors under human-induced loads. *Computers and Structures*, 136, 34-46. <https://doi.org/10.1016/j.compstruc.2014.01.027>
9. Wright, H.D., Evans, H.R. & Harding, P.W. (1987). The use of profiles steel sheeting in floor construction. *Journal of Constructional Steel Research*, 7(4), 279-295. [https://doi.org/10.1016/0143-974X\(87\)90003-4](https://doi.org/10.1016/0143-974X(87)90003-4)
10. Broms, C.E. (2006). *Concrete Flat Slabs and Footings: Design Method for Punching and Detailing for Ductility*. Royal Institute of Technology. Stockholm, Sweden.